

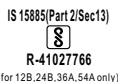

# 120W恒流型+恒压型LED驱动器

# HLG-120H系列

使用手册



## ■ 特性:

- 恒流模式+恒压模式输出
- 金属外壳,Class I 设计
- 内置主动式PFC功能
- IP67/IP65防护等级,户内户外安装均可
- 功能可选:输出内部电位器调整  
三合一调光;定时调光
- 寿命>62000小时
- 7年保固

## ■ 应用:

- LED街道照明
- LED高架照明
- 停车场照明
- LED捕鱼灯
- LED温室照明
- 适用于装在Class I, Division 2类  
危险地点之照明灯具

## ■ 全球交易品项识别码

MW搜寻: <http://www.meanwell.com.cn/serviceGTIN.aspx>

## ■ 描述:

HLG-120H系列是一款120W LED交流变直流电源供应器,以恒流输出和恒压输出设计为主要特色。此系列机型可工作在输入电压90~305VAC,并提供输出额定电压介于12V~54V间的多种机型。因具有最高可达93.5%之高转换效率,采用无风扇设计,可于自然风冷散热下工作于-40℃~+80℃之机壳温度范围。金属外壳以及IP67/IP65高防护等级之设计,使得HLG-120H对于户内或户外的应用均适用。HLG-120H搭配了多种功能选项(如数种调光方式),为灯具系统提供最佳的设计弹性。

## ■ 型号编码

HLG - 120H - 48 A

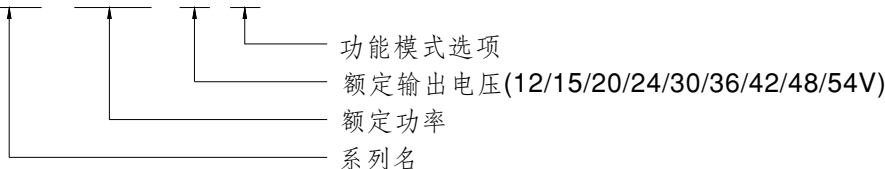

型号	IP等级	功能	备注
Blank	IP67	恒流输出和恒压输出值固定	标准品
A	IP65	恒流输出和恒压输出值可经内建电位器调整	标准品
B	IP67	三合一调光功能(1~10Vdc, 10V PWM信号和电阻)	标准品
AB	IP65	恒流输出和恒压输出值可经内建电位器调整& 三合一调光功能(1~10Vdc, 10V PWM信号和电阻)	标准品
D	IP67	定时调光功能,详情请联系明纬(安规申请中)	可选购

## 电气规格

型号		HLG-120H-12	HLG-120H-15	HLG-120H-20	HLG-120H-24	HLG-120H-30	HLG-120H-36	HLG-120H-42	HLG-120H-48	HLG-120H-54	
输出	直流电压	12V	15V	20V	24V	30V	36V	42V	48V	54V	
	恒电流范围 备注4	6~12V	7.5~15V	10~20V	12~24V	15~30V	18~36V	21~42V	24~48V	27~54V	
	额定电流	10A	8A	6A	5A	4A	3.4A	2.9A	2.5A	2.3A	
	额定功率	120W	120W	120W	120W	120W	122.4W	121.8W	120W	124.2W	
	纹波与噪声(最大)备注2	150mVp-p	150mVp-p	150mVp-p	150mVp-p	200mVp-p	200mVp-p	200mVp-p	200mVp-p	200mVp-p	
	电压调整范围	仅A/AB型可调(通过内部电位器)									
		10.8~13.5V	13.5~17V	17~22V	22~27V	27~33V	33~40V	38~46V	43~53V	49~58V	
	电流调整范围	仅A/AB型可调(通过内部电位器)									
		5~10A	4~8A	3~6A	2.5~5A	2~4A	1.7~3.4A	1.4~2.9A	1.2~2.5A	1.1~2.3A	
	电压精度 备注3	±2.5%	±2.0%	±1.0%	±1.0%	±1.0%	±1.0%	±1.0%	±1.0%	±1.0%	
线性调整率	±0.5%	±0.5%	±0.5%	±0.5%	±0.5%	±0.5%	±0.5%	±0.5%	±0.5%		
负载调整率	±2.0%	±1.5%	±0.5%	±0.5%	±0.5%	±0.5%	±0.5%	±0.5%	±0.5%		
启动,上升时间 备注6	1200ms,50ms/115VAC 500ms,50ms/230VAC										
保持时间(Typ.)	12ms / 115VAC, 230VAC										
输入	电压范围 备注5	90~305VAC 127~431VDC (请参考"静态特性曲线")									
	频率范围	47~63Hz									
	功率因数(Typ.)	PF≥0.98/115VAC, PF≥0.95/230VAC, PF≥0.93/277VAC@满载时 (请参考"功率因素特性曲线")									
	总谐波失真	THD<20%(@负载≥50%/115VAC,230VAC; @负载≥75%/277VAC) (请参考"总谐波失真特性曲线")									
	效率(Typ.)	92%	92%	93%	93%	93%	93%	93%	93.5%	93.5%	
	交流电流(Typ.)	1.4A / 115VAC		0.6A / 230VAC		0.55A / 277VAC					
	浪涌电流(Typ.)	冷启动60A(在50% Ipeak下测试twidth=375μs) @ 230VAC; Per NEMA 410									
	16A断路器可配置同型号电源供应器之数量	于230VAC时,可配置5台(B型断路器)/9台(C型断路器)									
	漏电流	<0.75mA / 277VAC									
保护	过电流	95~108% 恒流限制,负载异常条件移除后可自动恢复									
	短路	恒流限制,负载异常条件移除后可自动恢复									
	过电压	14~17V	18~21V	23~27V	28~34V	34~38V	41~46V	47~53V	54~63V	59~65V	
	过温度	关断输出电压,温度下降后可自动恢复									
环境	工作温度	Tcase=-40~+80°C(请参考"输出负载VS温度"部分)									
	最大外壳温度	Tcase=+80°C									
	工作湿度	20~95%RH,无冷凝									
	储存温度、湿度	-40~+80°C, 10~95%RH									
	温度系数	±0.03%/°C(0~60°C)									
	耐振动	10~500Hz,5G 12分钟/周期,X、Y、Z轴各72分钟									
安规和	安全规范 备注8	UL8750(type"HL"), CSA C22.2 No. 250.0-08, BS EN/EN 61347-1, BS EN/EN 61347-2-13,AS/NZS 61347-1(除AB型外), AS/NZS 61347-2-13(除AB型外) independent;GB19510.1,GB19510.14,IP65 or IP67, J61347-1, J61347-2-13(除D型外), BIS IS15885(仅12B,24B,36A,54A机型), EAC TP TC 004,KC61347-1,KC61347-2-13(除D型外)认证通过;									
	耐压	I/P-O/P:3.75KVAC I/P-FG:2.0KVAC O/P-FG:1.5KVAC									
电磁兼容	绝缘阻抗	I/P-O/P, I/P-FG, O/P-FG:100M Ohms / 500VDC / 25°C / 70% RH									
	电磁兼容发射 备注8	符合BS EN/EN55015, BS EN/EN55032 Class B, BS EN/EN61000-3-2 Class C (@负载≥50%); BS EN/EN61000-3-3,GB/T 17743,GB17625.1,EAC TP TC 020, KSC 9815(除D型外)									
	电磁兼容抗扰度	符合BS EN/EN61000-4-2,3,4,5,6,8,11; BS EN/EN61547, BS EN/EN55024, 轻工业标准(浪涌抗扰度:线对地4KV,线对线:2KV),EAC TP TC 020, KSC 9547(除D型外)									
其它	MTBF	2185.8K hrs min. Telcordia SR-332 (Bellcore); 167.1Khrs min. MIL-HDBK-217F (25°C)									
	尺寸	220*68*38.8mm (L*W*H)									
	包装	1.12Kg; 12pcs/14.4Kg/0.8CUFT									
备注	1. 如未特别说明,所有规格参数均在输入为230VAC、额定负载、25°C环境温度下进行量测。 2. 纹波和噪声测量方法:使用一条12"双绞线,同时终端要并联0.1uf和47uf的电容,在20MHZ带宽下进行量测。 3. 精度:包含设定误差、线性调整率和负载调整率。 4. 请参照"LED模块驱动方式"。 5. 低输入电压情况下需减额输出,详情请参照"静态曲线"部分。 6. 启动时间是在冷机启动下测得,频繁的开关机可能使启动时间增长。 7. 电源被视为一个元件与终端设备结合使用,因为EMC受整套装置的影响,终端设备制造商需对整套装置重新进行EMC确认。 (在明纬网站 <a href="https://www.meanwell.com/Upload/PDF/EMI_statement_cn.pdf">https://www.meanwell.com/Upload/PDF/EMI_statement_cn.pdf</a> ) 8. 这个LED电源只能在市电和LED电源之间加一个开关才能达到灯具最新ErP法规要求。 9. 当本系列机型的外壳最高温度点Tc低于75°C,使用工作寿命大于62000小时。 10. 请参照明纬网站 <a href="http://www.meanwell.com">http://www.meanwell.com</a> 上的保固声明。 11. 当海拔高度超过2000米(6500英尺)时,无风扇机型环境温度依每3.5°C/1000m比例下降,有风扇机型环境温度依每5°C/1000m比例下降。 12. 对于任何应用说明和IP防尘防水功能安装注意事项,请在设计安装前参阅我们的使用手册。 <a href="https://www.meanwell.com/Upload/PDF/LED_EN.pdf">https://www.meanwell.com/Upload/PDF/LED_EN.pdf</a> 13. A/AB type若需符合Type HL应用则需考虑内置使用。 ※ 产品免责声明:详情请参阅 <a href="http://www.meanwell.com.cn/serviceDisclaimer.aspx">http://www.meanwell.com.cn/serviceDisclaimer.aspx</a>										

## ■ 方框图

振荡频率: 100KHz

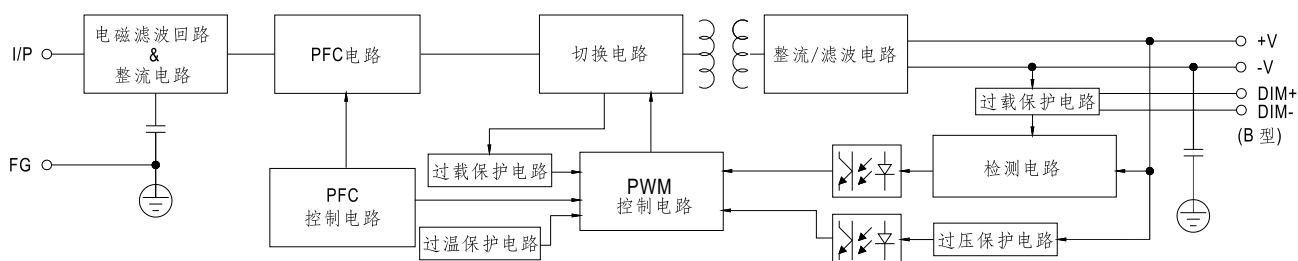

## ■ LED模块驱动方式

※ 这个系列既可以以恒流(CC)方式驱动(直接驱动)也可以以恒压(CV)方式驱动(带DC/DC驱动器)

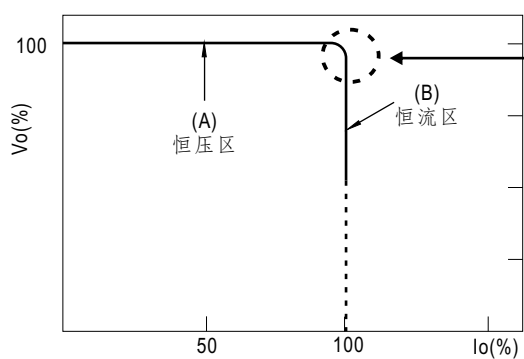

LED电源 I-V曲线

在恒流区, 驱动器的最高输出电压取决于终端系统的配置。如有搭配使用问题, 请洽询明纬

## ■ 调光操作

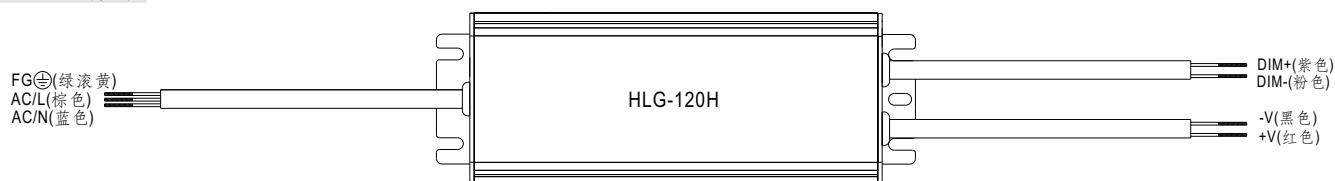

### ※ 三合一调光功能(仅B/AB型)

- 在DIM+和DIM-间连接一个电阻或连接1~10V直流电压或10V PWM信号,即可调整输出恒电流的数值
- 建议直接连接LED, 此系列不适合外加驱动器
- 调光端口输出电流: 100 $\mu$ A(典型值)

### ◎ 用外加1~10VDC电压

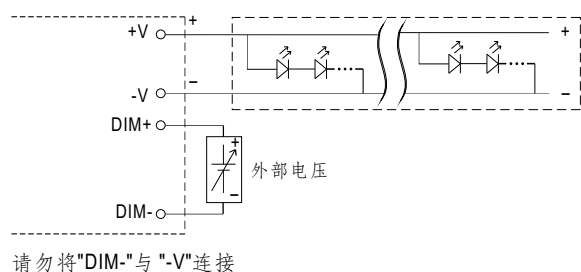

请勿将"DIM-"与"-V"连接

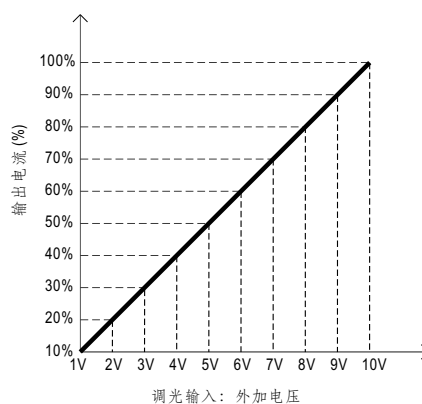

### ◎ 用外加10V PWM信号(频率范围:100Hz~3KHz):

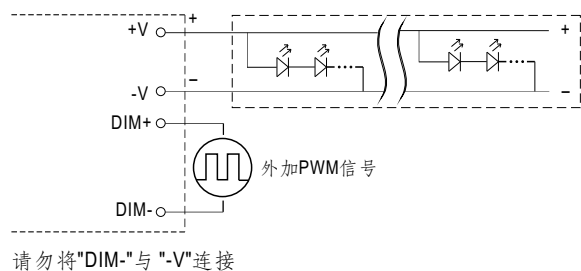

请勿将"DIM-"与"-V"连接

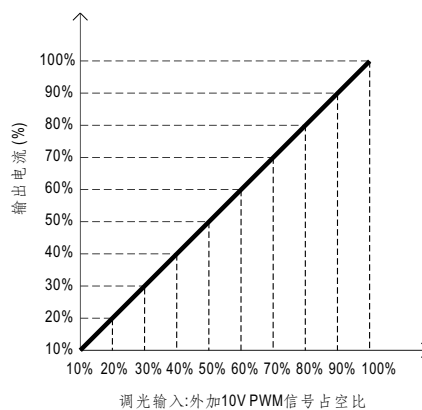

### ◎ 用外加电阻:

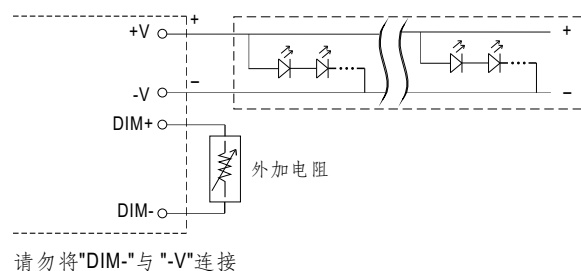

请勿将"DIM-"与"-V"连接

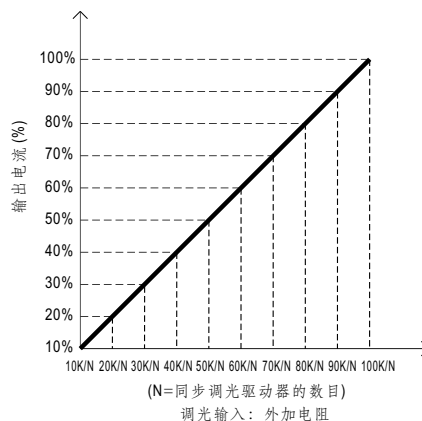

备注：要将灯源达到0%的亮度，请参照如下连接方法,或联系明纬选购其他可选机型

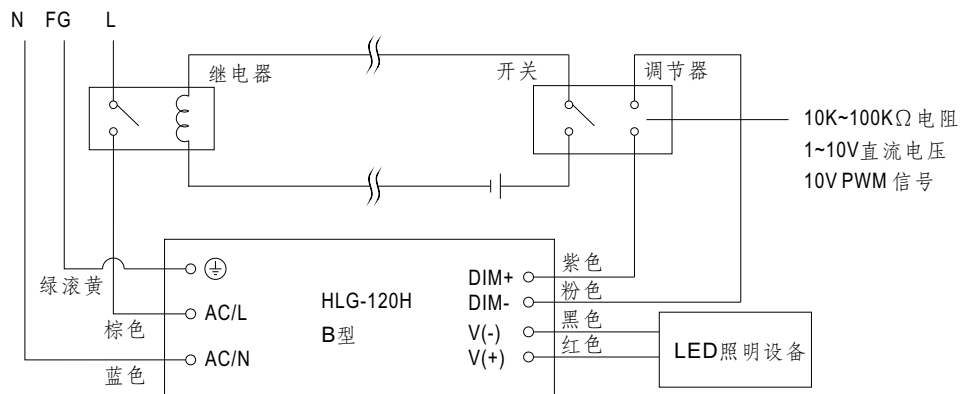

使用一个开关和继电器可以打开/关断照明设备

### ■ 输出负载vs温度(备注10)

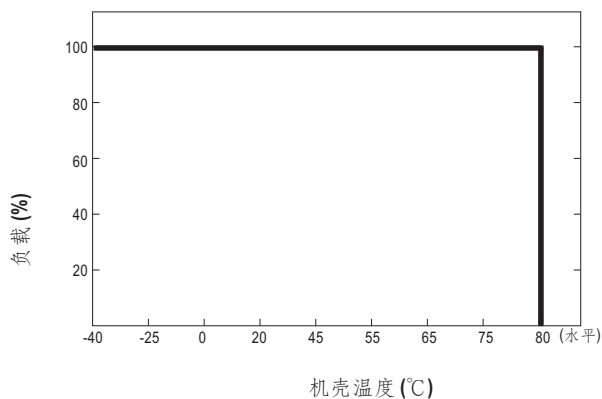
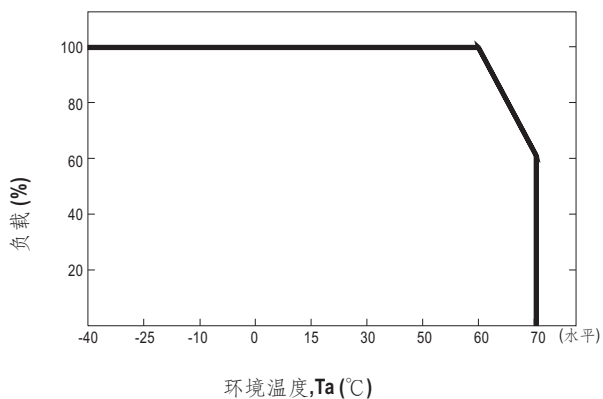

### ■ 静态特性曲线

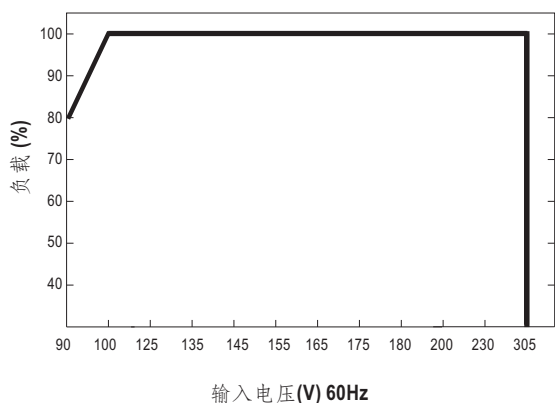

※ 低输入电压情况下需减额输出

### ■ 功率因素特性曲线

※ Tcase at 70°C

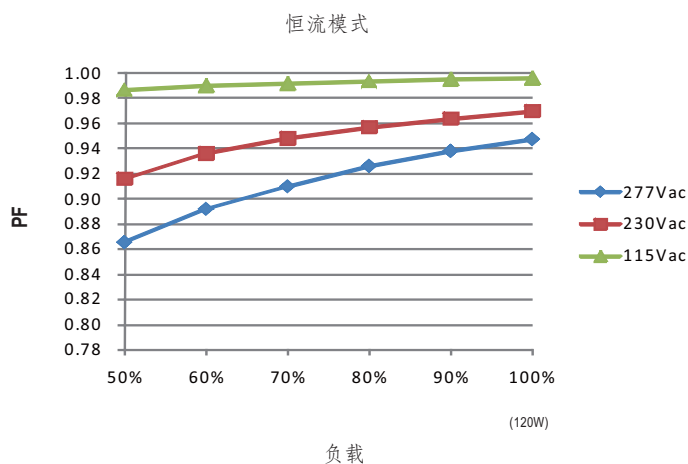

### ■ 总谐波失真特性曲线(THD)

※ 48V 机型, Tcase at 70°C

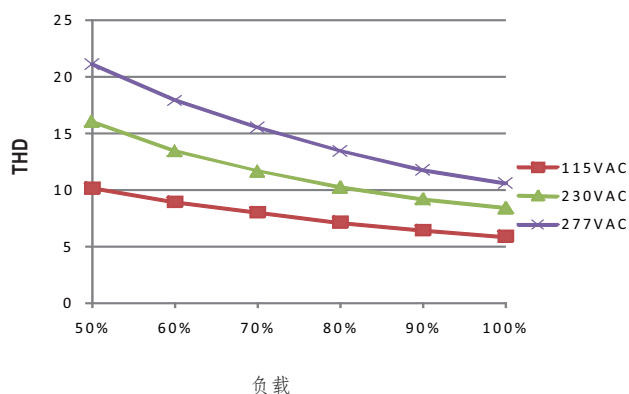

### ■ 效率 vs 负载

在实际应用中HLG-120H系列拥有高达93.5%的效率。

※ 48V机型, Tcase at 70°C

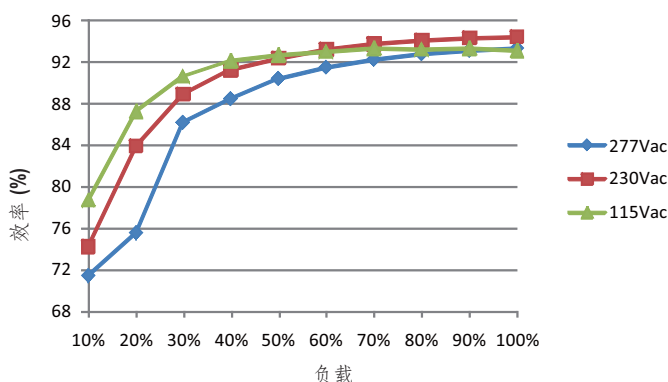

■ 寿命

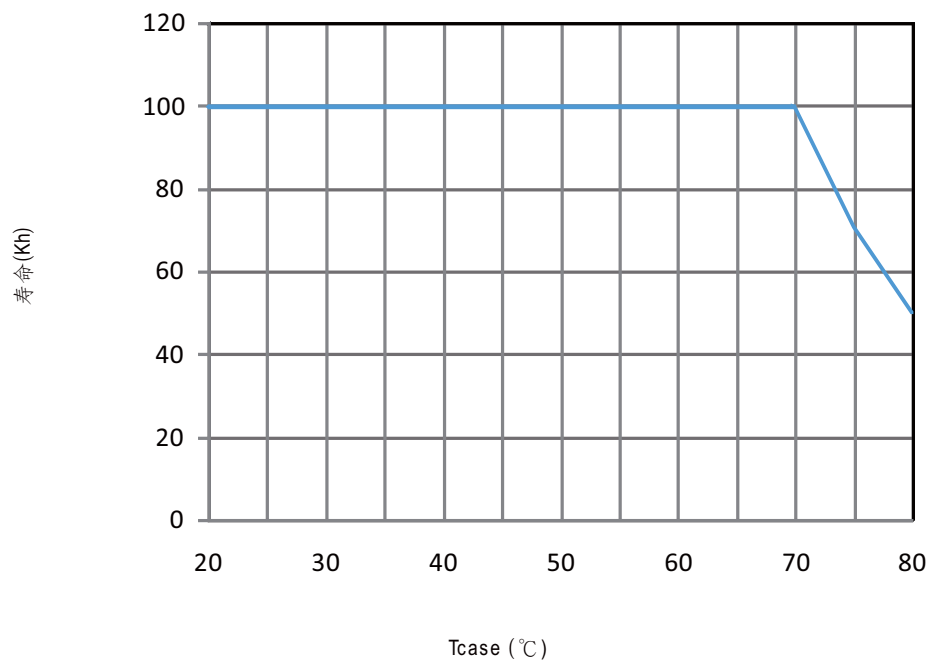

## ■ 机构尺寸

机壳型号: 994A 单位:mm 公差:±1

### ※Blank/D型

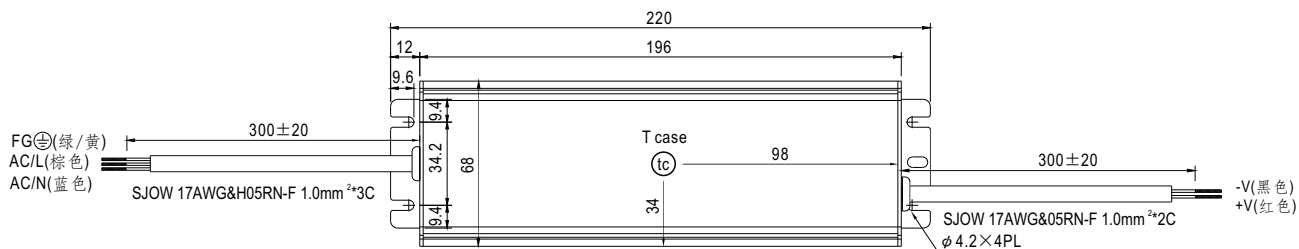

• (tc): 机壳最大温度

### ※A型

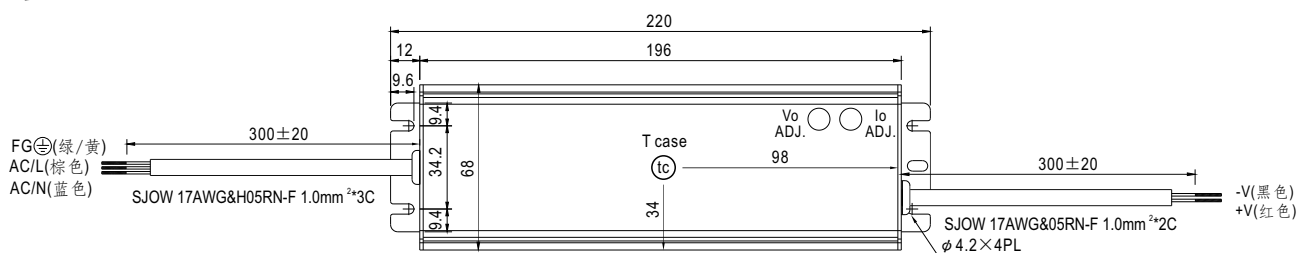

• (tc): 机壳最大温度



※B型

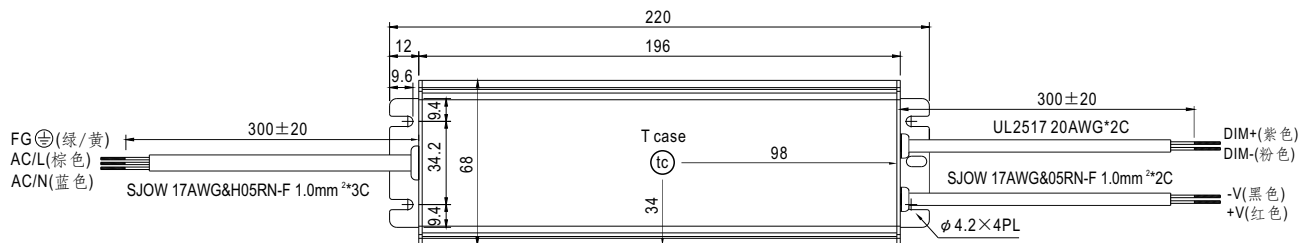

• (tc): 机壳最大温度



※AB型

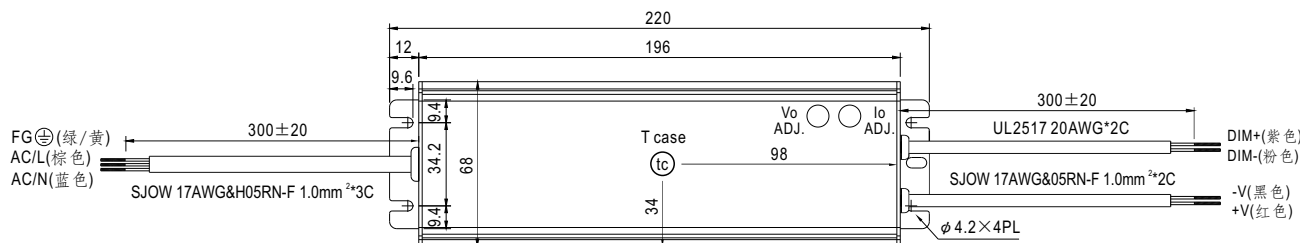

• (tc): 机壳最大温度

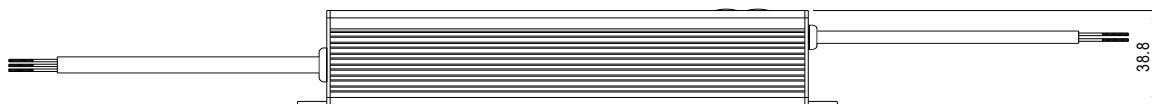

## ■ 防水接头

### ◎ 防水接头

防水接头可以组装在输出线上以适合在潮湿或室外环境下工作

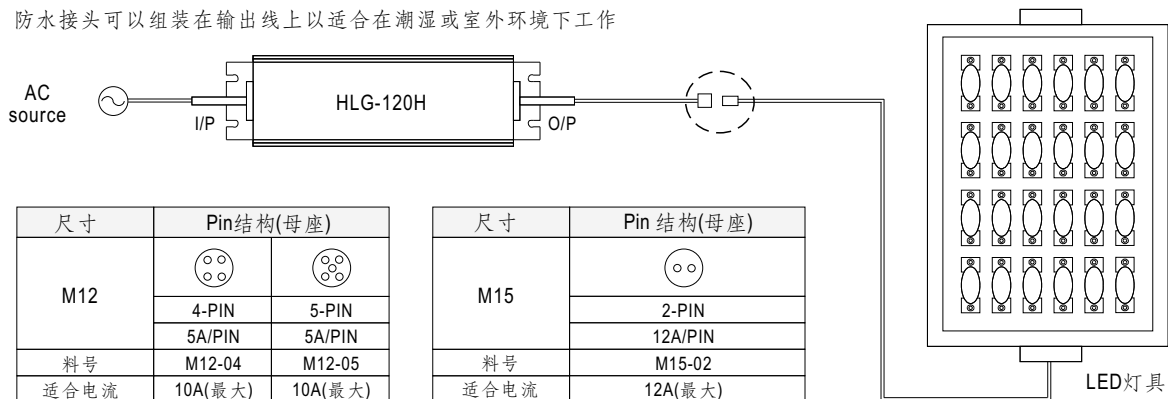

尺寸	Pin结构(母座)	
M12		
	4-PIN	5-PIN
	5A/PIN	5A/PIN
料号	M12-04	M12-05
适合电流	10A(最大)	10A(最大)

尺寸	Pin结构(母座)
M15	
	2-PIN
	12A/PIN
料号	M15-02
适合电流	12A(最大)

### ◎ 电缆接头

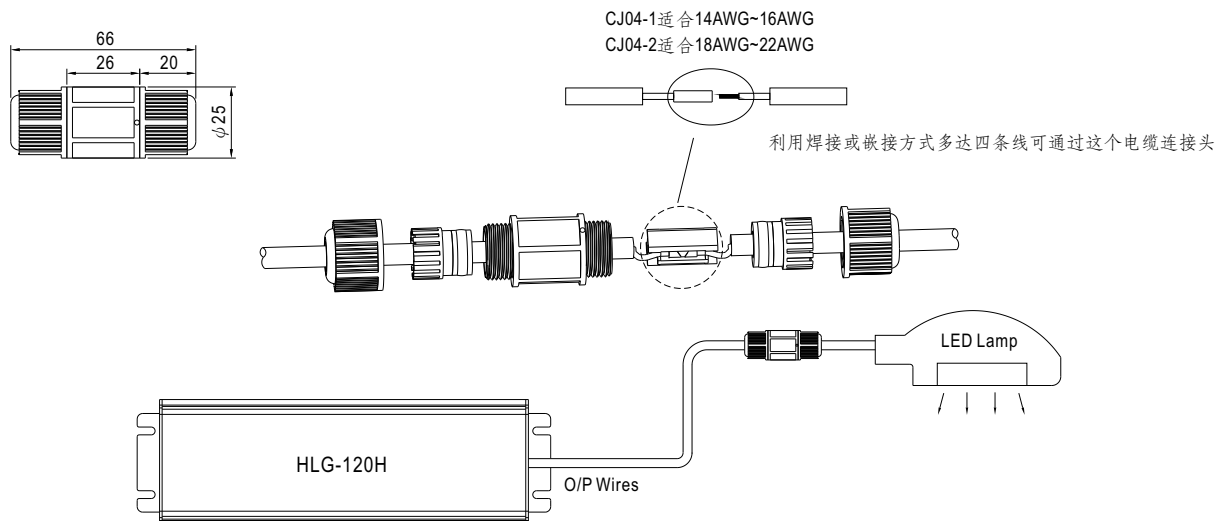

※ CJ04电缆接头客户可以单独订购自己安装  
明纬订购号: CJ04-1, CJ04-2.

### ※ 接线盒(可选)

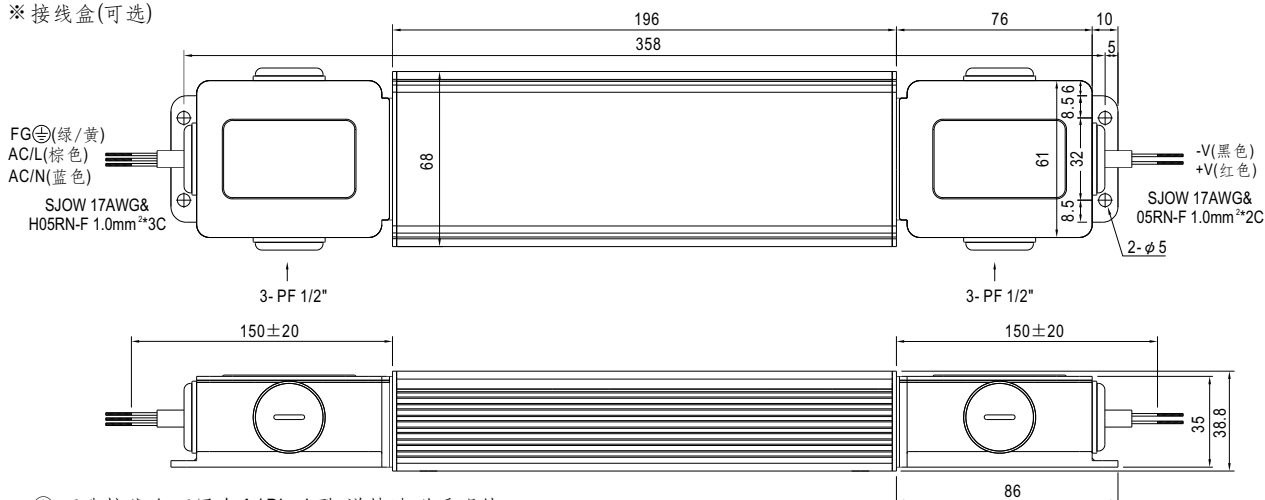

◎ 可选接线盒可用在 A/Blank型, 详情请联系明纬

## ■ 安装手册

请查阅: <http://www.meanwell.com/manual.html>