



Features

- 180~295VAC/220 ~ 417VDC input
- Constant Current mode output with multiple levels selectable by dip switch
- KNX protocol
- Support emergency lighting(EL)
- Integrated constant light output
- Integrated KNX push button interface
- Temperature compensation function by external NTC
- Class II power unit, ungrounded
- Full plastic case enclosed
- Protections: Short circuit / Over voltage / Over temperature
- Synchronization up to 10units
- Functions: Manual dim, operation hours, power consumption feedback, log/linear curve selection...etc
- 3 year warranty
- Suitable for intelligent LED lighting

Wiring

- Housing with cable clamp for remote installation
- Use wires with an adequate cross-section (see 6)
- Use suitable mounting tools to do the wiring and mounting (see 6)
- Use a MCB (miniature circuit breaker) with an adequate current rating to protect the lighting system (see 7)

Environmental limitations

- Maximum ambient temperature must not exceed 60°C
- Always allow adequate ventilation clearances, 50mm, around the unit in use to prevent it from overheating
- Only install the unit in interior environments

Cautions

- This unit must be installed by a qualified electrician
- This unit is not suitable for applications that DC/DC converters are connected before LED lamps

Settings and connections

1. Output Current Level Settings

The LCM can provide various output currents by setting the DIP switch. The settings of the DIP switch are shown in the tables below.

LCM-40KN

Voltage range	Selectable Current	1	2	3	4	5	6
2-100V	350mA	---	---	---	---	---	---
2-80V	500mA	ON	---	---	---	---	---
2-67V	600mA	ON	ON	---	---	---	---
2-57V	700mA*	ON	ON	ON	---	---	ON
2-45V	900mA	ON	ON	ON	ON	---	ON
2-40V	1050mA	ON	ON	ON	ON	ON	ON

LCM-60KN

Voltage range	Selectable Current	1	2	3	4	5	6
2-90V	500mA	---	---	---	---	---	---
2-90V	600mA	ON	---	---	---	---	---
2-86V	700mA*	ON	ON	---	---	---	---
2-67V	900mA	ON	ON	ON	---	---	ON
2-57V	1050mA	ON	ON	ON	ON	---	ON
2-42V	1400mA	ON	ON	ON	ON	ON	ON

- Note : 1.Factory default setting is 700mA.
2. Output voltage and output wattage must not exceed the rated values.

Terminal blocks assignment for LCM

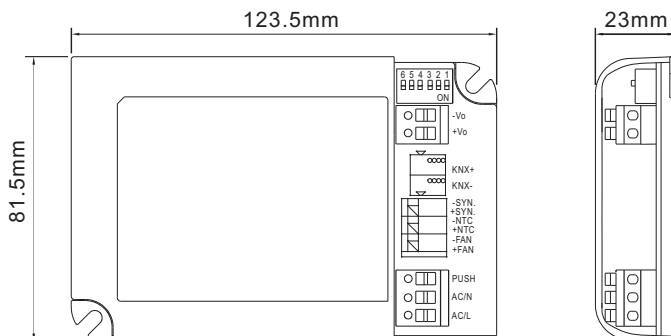

2. Connection of LED Lamps

Press down the "push button" by a slotted screw driver to insert or remove the cable.

Attention: Always connect LED lamps first before connect to 230Vac mains to avoid damage of LED!

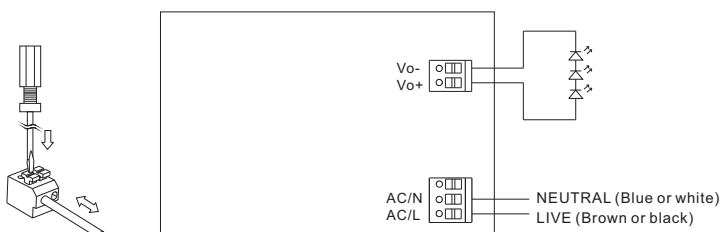

MEAN WELL
2019/12/4
ISSUE

3. Connection of Dimming Functions

a. KNX System

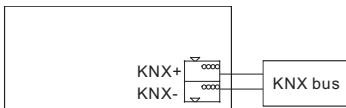

b. Push dimming

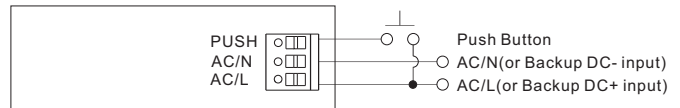

Note: ONLY use open push button without indicator light.

- KNX bus need to be connected in when using PUSH dimming.
- The detailed function of PUSH dimming, please refer to the database.
- The maximum length of the cable between the push button and driver is 20 meters.
- The additive push button can be connected only between the PUSH terminal, as displayed in the diagram, and AC/L (in brown or black); **it will lead to short circuit if it is connected to AC/N.**
- In case the PUSH dimming is set locally, up to 10 drivers can perform the PUSH dimming at the same time when utilizing one common push button.
- In case the PUSH dimming is set independently via ETS, the number of drivers is done through group address and determined by the ETS project designer.

c. Synchronization operation

- Synchronization up to 10 drivers (1 master + 9 slaves)
- Dimming operating range : 6%~100%
- Sync cable length : < 5m
- Sync cable type : Flat cable
- Sync cable cross section area : 22 – 24 AWG (0.2~0.3mm²)

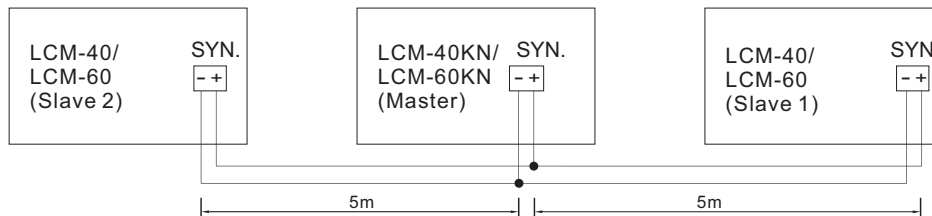

NOTE: 12. Max Dimming & Min. Dimming operating range depends on database setting.

4. AC/DC input monitor

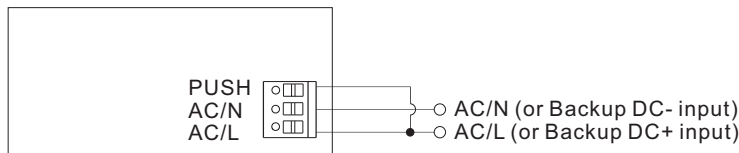

- KNX bus need to be connected when using AC/DC input monitor
- The detailed function of AC/DC input monitor, please refer to the database and instruction manual.

5. NTC Connection

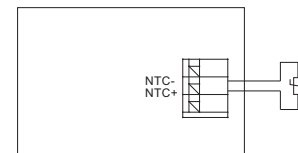

6. Recommended Screwdriver, Wire and Torque Setting

Type	The cover (the blue one)	Screw terminal (FAN±, NTC±, SYNC±)	Push terminal (ACL/N, PUSH, Vo±)
Solid wire	-----	φ 0.404 - φ 0.643mm	φ 1.024 - φ 1.628mm
Stranded wire	-----	0.129 - 0.326mm ²	0.823 - 2.08mm ²
American wire gauge	-----	22 - 26AWG	14 - 18AWG
Wire stripping length	-----	7mm (0.27")	10mm (0.39")
Screwdriver	6mm Phillips	3mm Phillips	3mm Phillips
Recommended tightening torque	4.6 kgf-cm (4 lb-in)	2.88 kgf-cm (2.5 lb-in)	-----
Suggested push-down strength	-----	-----	3 - 4 kp (6.61-8.81 lbf)

7. Suggested Maximum Number of the LCM Units that can be Connected to a MCB (miniature circuit breaker) at 230Vac

Model	B10	B16	C10	C16
LCM-40KN	13	21	22	35
LCM-60KN	13	20	22	34

Note: These calculated values are based on MCB S201 series manufactured by ABB.

MEANWELL
2019/12/4
ISSUE

8. Configuration and Commissioning

The application program(database) can be downloaded via Online Catalogs from ETS or via <http://www.meanwell.com/productCatalog.aspx>