



Test Report: RST-15K-115

15KW 3 ψ 4W Input With High Voltage Output

■ DESIGN VERIFY TEST

Output Function Test

Input Function Test

Protection Function Test

Control Function Test

Component Stress Test

■ SAFETY & E.M.C. TEST

Safety Test

E.M.C. Test

■ RELIABILITY TEST

ENVIRONMENT TEST

■ DESIGN VERIFY TEST

OUTPUT FUNCTION TEST

NO	TEST ITEM	SPECIFICATION	TEST CONDITION	RESULT
1	OUTPUT VOLTAGE ADJUST RANGE	CH1 : 90V~ 138 V	I/P : 230 VAC (Δ) O/P : MIN LOAD Ta : 25°C	85.90V~142.07V
2	OUTPUT VOLTAGE(Max) TOLERANCE	V1 : 1% ~ -1 %	I/P : 196VAC /305VAC (Δ) O/P : FULL/ MIN. LOAD Ta : 25°C	V1: 0%~ -0.495 %
3	LINE REGULATION (Max)	V1 : 0.5%~ -0.5 %	I/P : 230VAC~ 305VAC (Δ) O/P : FULL LOAD Ta : 25°C	V1: 0 %~ 0 %
4	LOAD REGULATION(Max)	V1 : 0.5%~ -0.5 %	I/P : 230VAC (Δ) O/P ; FULL ~MIN LOAD Ta : 25°C	V1: 0.46 %~ -0.06 %
5	OVER/UNDERSHOOT TEST	< \pm 10%	I/P : 230VAC (Δ) O/P : FULL LOAD Ta : 25°C	<10%
6	RIPPLE & NOISE(Max)	V1 : 1Vp-p	I/P : 230VAC (Δ) O/P : FULL LOAD Ta : 25°C	V1: 318mVp-p
<div style="display: flex; justify-content: space-around;"> <div style="width: 45%;"> <p>high frequency :</p> </div> <div style="width: 45%;"> <p>low frequency :</p> </div> </div>				
7	SET UP TIME(Max)	230VAC / 3000ms	I/P : 230 VAC (Δ) O/P : FULL LOAD Ta : 25°C	2560ms
<p>INPUT=230VAC/50HZ @ FULL LOAD CH3 : Output Voltage CH4 : AC Input Voltage</p>				

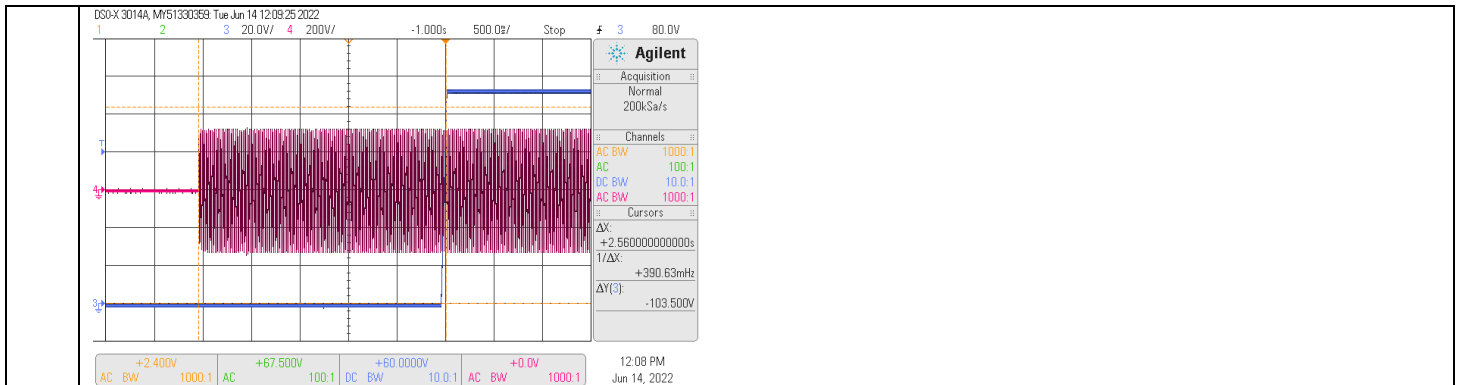

8	RISE TIME (Max)	230VAC/200ms	I/P : 230 VAC (Δ) O/P : FULL LOAD Ta : 25°C	50 ms
---	-----------------	--------------	---	-------

INPUT=230VAC/50HZ @ FULL LOAD

CH1 : Output Voltage

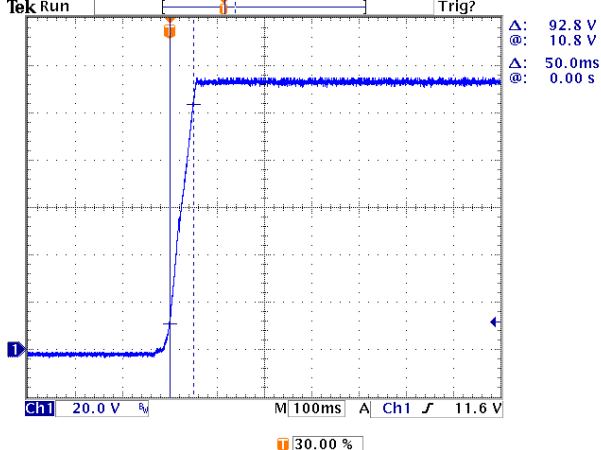

9	HOLD UP TIME (Typ.)	230VAC / 10ms at full load 230VAC / 16ms at 75% load	I/P : 230 VAC (Δ) O/P : FULL LOAD/75% LOAD Ta : 25°C	Full Load/ 18 ms 75% Load/ 26 ms
---	---------------------	---	--	-------------------------------------

INPUT=230VAC/50HZ @ FULL LOAD

CH3 : Output Voltage CH1,2,4 : AC Input Voltage

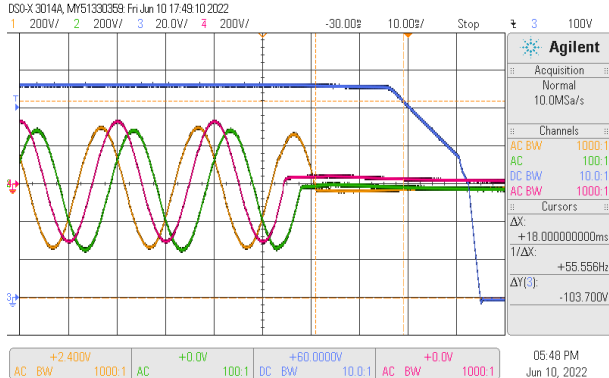

INPUT=230VAC/50HZ @ 75% LOAD

CH3 : Output Voltage CH1,2,4 : AC Input Voltage

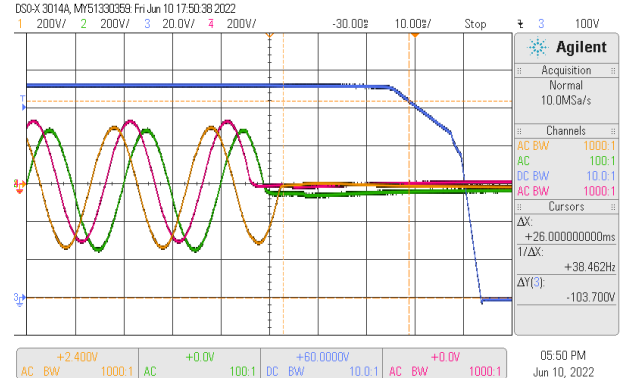

10	DYNAMIC LOAD	V1: 11.5Vp-p	I/P: 230VAC O/P: (1)FULL /50% LOAD 50%DUTY / 120HZ (2)FULL /50% LOAD 50%DUTY / 1KHZ Ta:25°C	2.41Vp-p 2.17Vp-p
----	--------------	--------------	---	----------------------

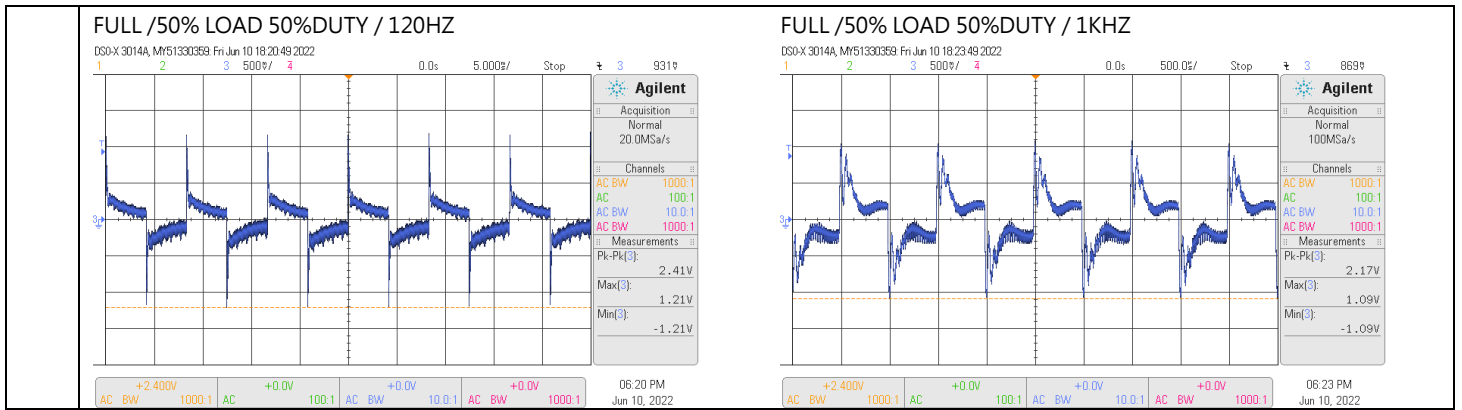

INPUT FUNCTION TEST

NO	TEST ITEM	SPECIFICATION	TEST CONDITION	RESULT
1	INPUT VOLTAGE RANGE	196VAC~305VAC	(1) I/P:TESTING O/P:FULL LOAD Ta:25°C	(1) 185.9 V~305 V
			I/P : LOW-LINE 196-3V=193V HIGH-LINE 305+10V=315 V O/P : FULL/MIN LOAD (PLEASE CHECK DERATING CURVE) ON : 30 Sec OFF : 30 Sec 10MIN (POWER ON/OFF NO DAMAGE)	TEST: PASS
2	INPUT FREQUENCY RANGE	47HZ ~63 HZ NO DAMAGE	I/P: 196VAC ~305 VAC(Δ) O/P: FULL~MIN LOAD Ta:25°C	TEST: PASS
3	INPUT CURRENT (Typ.)	Y : 400V/ 26A Δ : 230V/ 45A	I/P : 400VAC(Y)/230 VAC(Δ) O/P : FULL LOAD Ta : 25°C	Y : I =23.36A Δ : I =40.40A
4	LEAKAGE CURRENT	<21mA / 305 VAC(Δ) < 3.5mA /530VAC (Y)	I/P : 305VAC (Δ) / 530V (Y) O/P : Min LOAD Ta : 25°C	L1-FG : 20.52mA/ 1.78mA(Y) L2-FG : 20.52mA/ 1.78mA(Y) L3-FG : 20.52mA/ 1.78mA(Y)
5	POWER FACTOR (Typ.)	0.98 / 230VAC 0.97 / 277VAC	I/P : 230 VAC (Δ) I/P : 277 VAC (Δ) O/P : FULL LOAD Ta : 25°C	PF=0.984 / 230VAC PF=0.979 / 277VAC
	P.F vs LOAD			

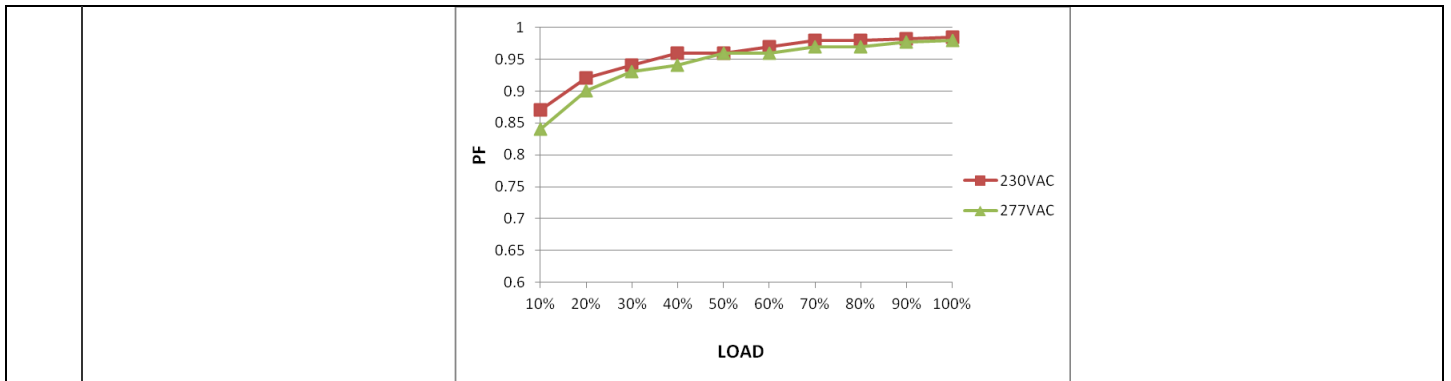

6	EFFICIENCY(Typ.)	93%	I/P:230 VAC(Δ) O/P:FULL LOAD Ta:25°C	94.5 %
---	------------------	-----	---	--------

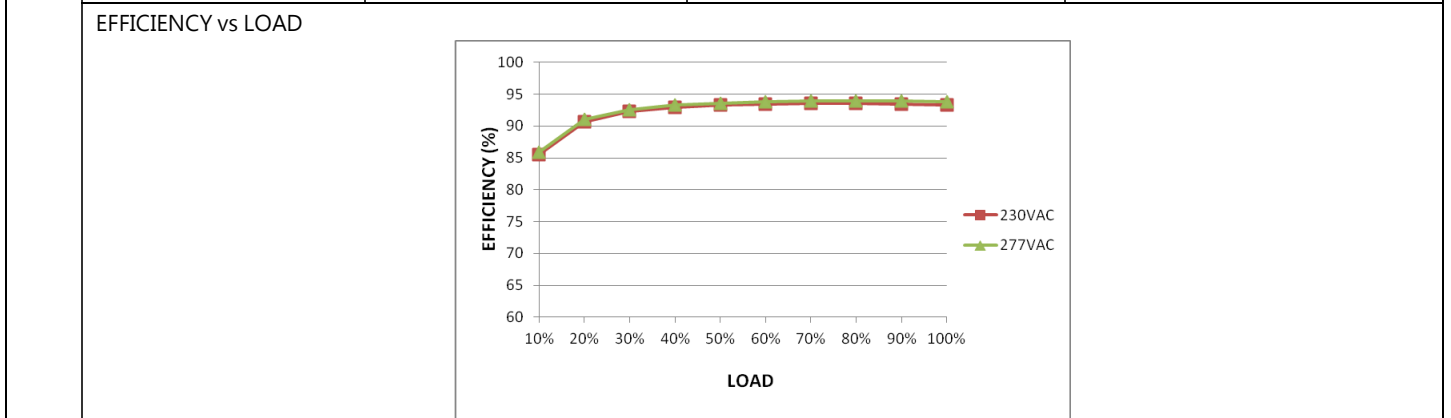

7	INRUSH CURRENT(Typ.)	Y : 400V/ 100A Δ : 230V/ 150A COLD START	I/P : 400VAC (Y) I/P : 230 VAC (Δ) O/P : FULL LOAD Ta : 25°C	Y : 55.5A Δ : 107A T50= 2.8 ms (Δ)
---	----------------------	---	--	--

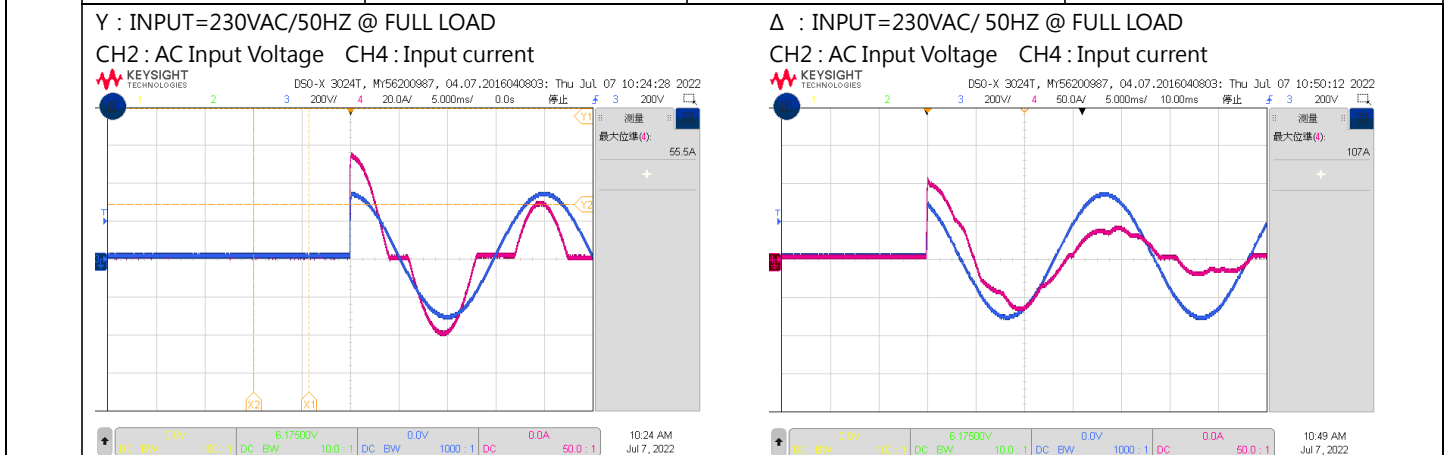

PROTECTION FUNCTION TEST

NO	TEST ITEM	SPECIFICATION	TEST CONDITION	RESULT
1	OVER LOAD PROTECTION	100 %~107 % Constant current limiting, unit will shutdown after 5 sec. re-power on to recover	I/P : 305VAC(Δ) I/P : 230VAC I/P : 196VAC O/P : TESTING Ta : 25°C	100.77%/ 305VAC 100.77%/ 230VAC 100.77%/ 196VAC PROTECTION TYPE : Constant current limiting, unit will shutdown after 5 sec. re-power on to recover
2	OVER VOLTAGE PROTECTION	145V~166V Protection type : Shut down o/p voltage, re-power on to recover	I/P: 305VAC(Δ) I/P: 230VAC I/P: 196VAC O/P:MIN LOAD Ta:25°C	152.8V/ 305VAC 152.8V/ 230VAC 152.8V/ 196VAC PROTECTION TYPE : Shut down o/p voltage, re-power on to recover
3	OVER TEMPERATURE PROTECTION	Protection type : Shut down o/p voltage, recovers automatically after temperature goes down	I/P: 305VAC(Δ) I/P: 196VAC O/P:FULL LOAD	O.T.P. Active Protection type : Shut down o/p voltage, recovers automatically after temperature goes down
4	SHORT PROTECTION	SHORT EVERY OUTPUT 1 HOUR NO DAMAGE Protection type : Constant current limiting, unit will shutdown after 5 sec. re-power on to recover	I/P: 305VAC(Δ) I/P: 196VAC O/P: FULL LOAD Ta:25°C	NO DAMAGE PROTECTION TYPE : Constant current limiting, unit will shutdown after 5 sec. re-power on to recover

CONTROL FUNCTION TEST

NO	TEST ITEM	SPECIFICATION	TEST CONDITION	RESULT						
1	AUXILIARY POWER (AUX)	I/P: 230 VAC(Δ) O/P:FULL LOAD Ta:25°C Test Result : PASS								
		<table border="1"> <thead> <tr> <th>AUX</th> <th>TOLERANCE</th> <th>TEST RESULT</th> </tr> </thead> <tbody> <tr> <td>12V / 0.1A</td> <td>11.4~12.6 V</td> <td>11.89V/31mvp-p</td> </tr> </tbody> </table>			AUX	TOLERANCE	TEST RESULT	12V / 0.1A	11.4~12.6 V	11.89V/31mvp-p
AUX	TOLERANCE	TEST RESULT								
12V / 0.1A	11.4~12.6 V	11.89V/31mvp-p								
2	REMOTE ON/OFF CONTROL	I/P: 230 VAC(Δ) O/P:FULL LOAD Ta:25°C Test Result : PASS								
		<table border="1"> <thead> <tr> <th>Between Remote ON-OFF(CN25 pin5) and 12V-AUX(CN25 pin1)</th> <th>Output Status</th> </tr> </thead> <tbody> <tr> <td>Switch close (Short)</td> <td>power supply ON</td> </tr> <tr> <td>Switch open (Open)</td> <td>power supply OFF</td> </tr> </tbody> </table>			Between Remote ON-OFF(CN25 pin5) and 12V-AUX(CN25 pin1)	Output Status	Switch close (Short)	power supply ON	Switch open (Open)	power supply OFF
Between Remote ON-OFF(CN25 pin5) and 12V-AUX(CN25 pin1)	Output Status									
Switch close (Short)	power supply ON									
Switch open (Open)	power supply OFF									

3 Select Overload Protection (OLP) Mode

3.1. Continuous Constant Current mode
 Have the DIP switch position-1 set as , and RST-15K will work in continuous constant current mode when the output is overloaded and the output voltage is greater than 50% of the rated output voltage.

3.2. Delay Shutdown mode
 Have the DIP switch position-1 set as , and RST-15K will shut down after 5 seconds of constant current operation, when the output is overloaded or short-circuited.

I/P: 230 VAC(Δ)
 O/P: 90V Load : CV Mode 90-2V
 Ta:25°C
 Test Result : PASS

4 OUTPUT VOLTAGE PROGRAMMABLE(PV)

1. Output Voltage Programming (or, PV / remote voltage programming / remote adjust / margin programming / dynamic voltage trim)

(1) by potentiometer (SVR)
 (a) Have the DIP switch position-3 set as
 (b) Output voltage can be trimmed by SVR.

(2) by Output Voltage Programming
 (a) Have the DIP switch position-3 set as
 (b) The output voltage can be trimmed to 1~120% by applying EXTERNAL VOLTAGE between PV+ and PV- on CN26 or CN27.

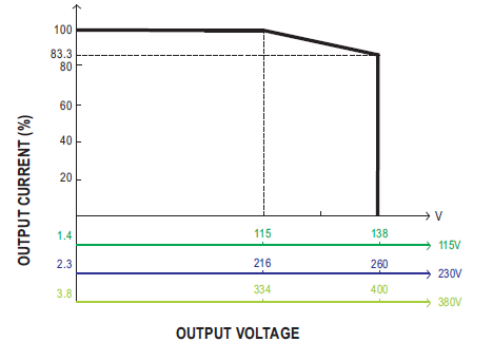
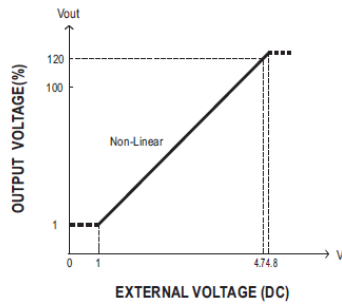
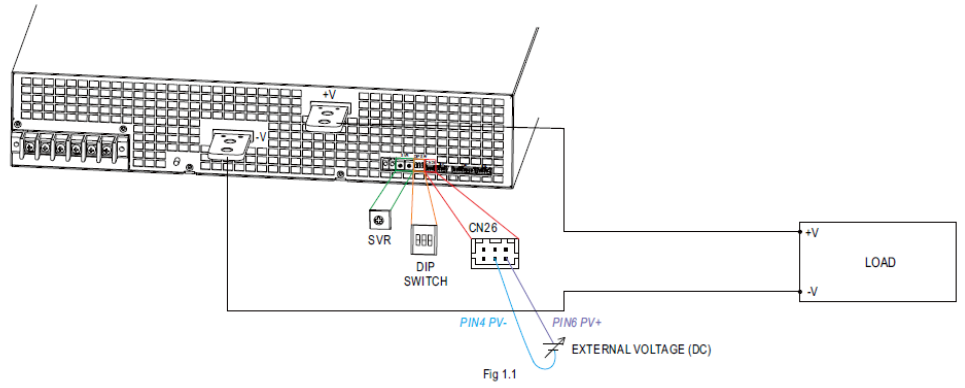

© The rated current should change with the Output Voltage Programming accordingly.

Fig 1.2

I/P : 230 VAC(Δ)
 O/P : FULL LOAD
 Ta : 25°C
 TEST RESULT : PASS

PV	1V	4.7V
MODEL		
SPEC	1.4V \pm 0.94V	138V \pm 3.76V
Vout	1.91V	139.01V

5 OUTPUT CURRENT PROGRAMMABLE (PC)

2.Constant Current Programming (or, PC / remote current programming / dynamic current trim)

(1)Default Overload Protection(OLP) 100~105% of rated current

(a)Have the DIP switch position-2 set as 

(b)Output current is set default value.

(2)by Constant Current Level Programming 

(a)Have the DIP switch position-2 set as

(b)The constant current level can be trimmed to 20~100% of the rated current by applying EXTERNAL VOLTAGE between PC+ and PC- on CN26 or CN27.

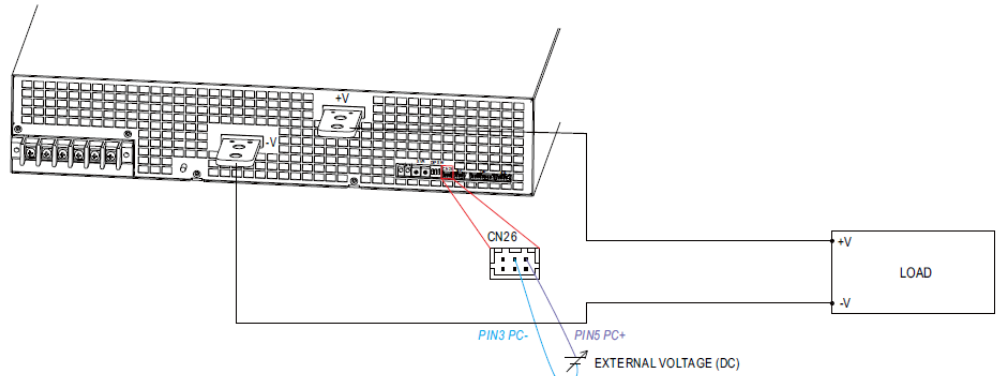

Fig 2.1

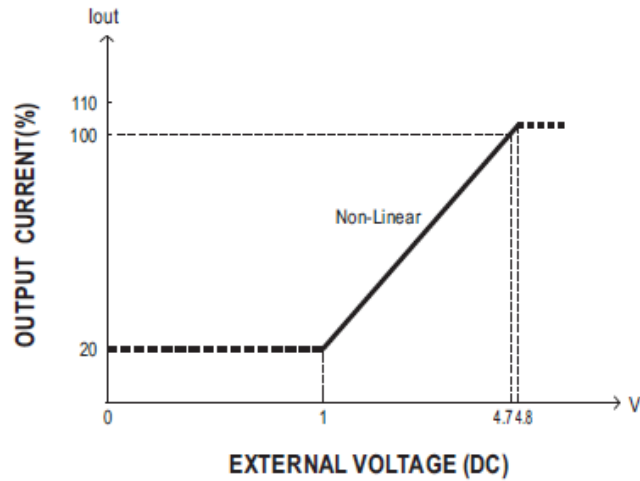

Fig 2.2

Output will shut down after O/P voltage is below <80% of Vset for 6 sec, re-power on to recover.

I/P: 230 VAC(Δ)

O/P:TESTING

Ta:25°C

ADJ V	1V	4.7V
SPEC	20% \pm 10%	100% \pm 10%
TEST	21%	100.1%

6 Alarm Signal Output

5.Alarm Signal Output

※ There are 4 alarm signals on CN99, and each signal can select two types of output circuit.

(1)Relay contact output {OTP1, OTP1-GND} ; (DC-OK1, DC-OK1-GND) ; (AC-FAIL1-GND, AC-FAIL1) ; (FAN-FAIL1-GND, FAN-FAIL1)}
Normally open contact. "Short" when the alarm arises. Relay contact rating(maximum) is 30V/1A resistive.

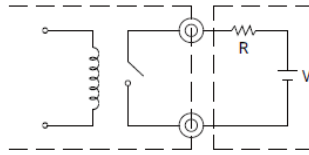

Fig 5.1

Function	Description
DC-OK1	Alarm signal of DC-OK. Normally open contact. "Short" when the PSU turns on. Relay contact rating(maximum) is 30V/1A resistive.
OTP1	Alarm signal of OTP. Normally open contact. "Short" when the PSU over temperature protection occurs. Relay contact rating(maximum) is 30V/1A resistive.
AC_Fail_1	Alarm signal of AC-fail. Normally open contact. "Short" when the PSU input voltage is too low. Relay contact rating(maximum) is 30V/1A resistive.
FAN_Fail_1	Alarm signal of fan fail. Normally open contact. "Short" when the internal fan fails. Relay contact rating(maximum) is 30V/1A resistive.

I/P : 230 VAC(Δ)

O/P : no load/full load

Ta : 25°C

TEST RESULT : PASS

Power Supply Status	DC-OK1 signal	OTP1 signal	AC_Fail_1 signal	FAN_Fail_1 signal
OFF	OPEN	SHORT	SHORT (184VAC)	SHORT
ON	SHORT	OPEN	OPEN (189VAC)	OPEN

(2)Open collector output {DC-OK2-GND, DC-OK2} ; (AC-FAIL2-GND, AC-FAIL2) ; (OTP2, OTP2-GND) ; (FAN-FAIL2, FAN-FAIL2-GND)}

An external voltage source is required for this function that is shown in Fig 5.2. These signals are isolated from output. The maximum sink current is 10mA and the maximum external voltage is 20V (there is a built-in 24V zener diode in inner circuitry).

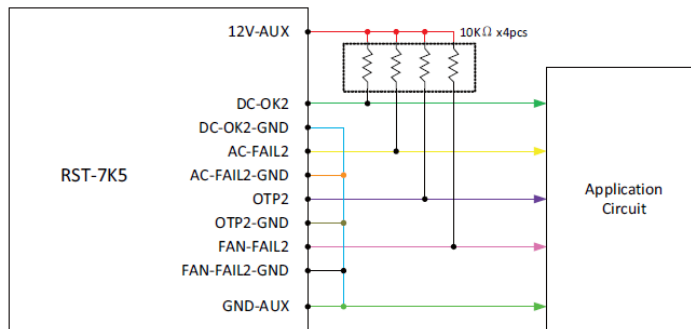

Function	Description
DC-OK2	Alarm signal of DC-OK. Open collector signal. Low when the PSU turns on. The maximum sink current is 10mA and the maximum external voltage is 20V.
OTP2	Alarm signal of OTP. Open collector signal. Low when the PSU over temperature protection occurs. The maximum sink current is 10mA and the maximum external voltage is 20V.
AC-FAIL2	Alarm signal of AC fail. Open collector signal. Low when the PSU input voltage is too low. The maximum sink current is 10mA and the maximum external voltage is 20V.
FAN-FAIL2	Alarm signal of fan fail. Open collector signal. Low when the internal fan fails. The maximum sink current is 10mA and the maximum external voltage is 20V.



		Power Supply Status	DC-OK1 signal	OTP1 signal	AC_Fail_1 signal	FAN_Fail_1 signal
		OFF	HIGH	LOW	LOW (184VAC)	LOW
		ON	LOW	HIGH	HIGH (188VAC)	HIGH
7	CURRENT SHARING	CURRENT SHARING TOLERANCE $\pm 10\%$		I/P : 230 VAC(Δ) O/P : 100/50% LOAD Ta : 25°C	O/P : 100% PSU1 : 131.96 A PSU2 : 129.11 A O/P : 50% PSU1 : 66.05 A PSU2 : 65.03 A	

COMPONENT STRESS TEST

NO	TEST ITEM	SPECIFICATION	TEST CONDITION	RESULT
1	PWM Transistor (D to S) or (C to E) Peak Voltage	Q333 Rated : 35A/650V VGS : -10V~+22V Q334 Rated : 35A/650V VGS : -10V~+22V	AC ON/OFF I/P : High-Line +3V =308V VDS : <u>VO : 115V</u> O/P : (1)Full Load (2)Output Short (3)Dynamic Load Full Load/ Min. Load 90%Duty/1KHz (4)Dynamic Load Full Load/ Min. Load 90%Duty/3KHz (5)Dynamic Load Full Load/ Min. Load 90%Duty/5KHz (6)Dynamic Load 100% Load/ Min. Load 50%Duty/120Hz (7)0%→160% Load. Ta:25°C	<u>Q333</u> AC=308V <u>VO : 115V</u> VDS: (1) 533V (2) 608V (3) 537V (4) 533V (5) 529V (6) 581V (7) 644V <u>Q334</u> AC=308V <u>VO : 115V</u> VDS: (1) 477V (2) 497V (3) 477V (4) 477V (5) 473V (6) 509V (7) 521.7V
2	P.F.C Transistor (D to S) or (C to E) Peak Voltage	Q100 Rated : 35A/650V VGS : -8V~+19V	I/P : High-Line +3V =308V AC ON/OFF <u>VO : 115V</u> O/P : (1)Full Load (2)Output Short (3)Dynamic Load Full Load/ Min. Load 90%Duty/1KHz (4)Dynamic Load Full Load/ Min. Load 90%Duty/3KHz (5)Dynamic Load Full Load/ Min. Load 90%Duty/5KHz (6)Dynamic Load 100% Load/ Min. Load 50% Duty/ 120Hz (7)0%→160% Load. Ta : 25°C	<u>VO : 115V</u> VDS (1) 573V (2) 577V (3) 565V (4) 561V (5) 561V (6) 505V (7) 614V

3	P.F.C DIODE	D108 Rated : 20A/650V	I/P : High-Line +3V =308V AC ON/OFF <u>VO : 115V</u> O/P : (1)Full Load (2)Output Short (3)Dynamic Load Full Load/ Min. Load 90%Duty/5KHz (4)Dynamic Load 100% Load/Min.Load 50%Duty/ 120Hz Ta : 25°C	<u>VO : 115V</u> (1) 477V (2) 477V (3) 481V (4) 485V
4	Diode Peak Voltage	D711 Rated : 20A/650V	AC ON/OFF I/P : High-Line +3V =308V <u>VO : 115V</u> O/P : (1)Full Load (2)Output Short (3)Dynamic Load Full Load/ Min. Load 90% Duty/ 1KHz (4)Dynamic Load Full Load/ Min. Load 90% Duty/ 3KHz (5)Dynamic Load Full Load/ Min. Load 90% Duty/ 5KHz (6)Dynamic Load 100% Load/Min. Load 50% Duty/ 120Hz (7)0%→160% Load. (8).NO LOAD Ta : 25°C	<u>VO : 115V</u> (1) 493V (2) 493V (3) 505V (4) 497V (5) 497V (6) 521V (7) 577V (8) 433V
5	Input Capacitor Voltage	C300~C302 Rated : 390uF/450V 105°C/MXK Series Surge Voltage: 500V	I/P : High-Line +3V =308V <u>VO : 115V</u> O/P : (1) Full Load input on/off (2) Min load input on/Off (3) Full Load/Min load Change (4) Full load continue Ta : 25°C	<u>VO : 115V</u> (1) 445V (2) 433V (3) 450V (4) 424V
6	Control IC Voltage Test	MCU IC(control IC) U901 Rated : 2V~3.6V	AC ON/OFF I/P : High-Line +3V =308V <u>VO : 115V</u> O/P : (1) FULL LOAD (2) Output Short (3) O.L.P (4) O.V.P (5) NO LOAD VRmin(LOW LINE) Ta : 25°C	U901 : <u>VO : 115V</u> (1) 3.285V (2) 3.297V (3) 3.297V (4) 3.297V (5) 3.293V
7	TOP SWITCHING STAND BY POWER	U601 Rated : 4 A/800V	AC ON/OFF <u>VO : 115V</u>	U601 <u>VO : 115V</u>

			I/P : High-Line +3V =308V O/P : (1)Full Load (2)Remote On/Off Ta : 25°C	(1) 634V (2) 640V
--	--	--	--	----------------------

■ SAFETY& E.M.C. TEST

SAFETY TEST

NO	TEST ITEM	SPECIFICATION	TEST CONDITION	RESULT
1	WITHSTAND VOLTAGE	I/P-O/P: 4.3KVDC/min I/P-FG : 2.8KVDC/min O/P-FG: 2.8KVDC/min	I/P-O/P: 4.8 KVDC/min I/P-FG : 3.4KVDC/min O/P-FG: 3.4 KVDC/min Ta:25°C	I/P-O/P: 0.03mA I/P-FG: 0.03mA O/P-FG: 0.03m A NO DAMAGE
2	ISOLATION RESISTANCE	I/P-O/P: 500VDC>100M Ω O/P-FG: 500VDC>100M Ω I/P-FG: 500VDC>100M Ω	I/P-O/P: 500 VDC I/P-FG : 500 VDC O/P-FG: 500 VDC Ta:25°C	I/P-O/P: 1.99 G Ω I/P-FG: 4.7 G Ω O/P-FG: 5.56 G Ω NO DAMAGE
3	GROUNDING CONTINUITY	FG(PE) TO CHASSIS OR TRACE < 100 m Ω	100A / 4min Ta:25°C	0.6m Ω

E.M.C TEST

NO	TEST ITEM	SPECIFICATION	TEST CONDITION	RESULT
1	HARMONIC	EN61000-3-12 CLASS A	I/P:230VAC/50HZ O/P:FULL LOAD Ta:25°C	PASS
2	CONDUCTION	EN55032 /EN55011 CLASS B	I/P : 230 VAC (50HZ) O/P : FULL/50% LOAD Ta : 25°C	PASS
3	RADIATION	EN55032 /EN55011 CLASS A	I/P : 230 VAC (50HZ) O/P : FULL LOAD Ta : 25°C	PASS
4	E.S.D	EN61000-4-2 Level 3, 8KV air ; Level 2, 4KV contact	I/P : 230 VAC/50HZ O/P : FULL LOAD Ta : 25°C	CRITERIA A PASS
5	E.F.T	EN61000-4-4 INDUSTRY INPUT : 2KV	I/P : 230 VAC/50HZ O/P : FULL LOAD Ta : 25°C	PASS
6	SURGE	IEC61000-4-5 INDUSTRY L-N : 2KV	I/P : 230 VAC/50HZ O/P : FULL LOAD Ta : 25°C	CRITERIA A

		L,N-PE : 4KV	
7	Test by certified Lab & Test Report Prepare Any contradictions of the test results, please refer to the latest EMC test report		

■ RELIABILITY TEST

ENVIRONMENT TEST

NO	TEST ITEM	SPECIFICATION	TEST CONDITION	RESULT																																																																																																																												
1	TEMPERATURE RISE TEST	MODEL : RST-15K-380 1. ROOM AMBIENT BURN-IN : 1 HRS I/P : 230VAC (Δ) O/P : FULL LOAD Ta= 25 °C 2. HIGH AMBIENT BURN-IN : 1.5 HRS I/P : 230VAC (Δ) O/P : FULL LOAD Ta= 45 °C																																																																																																																														
				<table border="1"> <thead> <tr> <th>NO</th> <th>Position</th> <th>ROOM AMBIENT Ta= 25 °C</th> <th>HIGH AMBIENT Ta= 45 °C</th> </tr> </thead> <tbody> <tr><td>1</td><td>A board-Q151</td><td>83.8</td><td>101.2</td></tr> <tr><td>2</td><td>A board-D153</td><td>86.9</td><td>105.5</td></tr> <tr><td>3</td><td>A board-Q100</td><td>76.9</td><td>94.5</td></tr> <tr><td>4</td><td>A board-D108</td><td>81.3</td><td>99.7</td></tr> <tr><td>5</td><td>A board-BD100</td><td>71.4</td><td>89.4</td></tr> <tr><td>6</td><td>A board-BD151</td><td>83.7</td><td>101.8</td></tr> <tr><td>7</td><td>A board-L151</td><td>38.2</td><td>57.1</td></tr> <tr><td>8</td><td>D board-Q332</td><td>59.1</td><td>78.1</td></tr> <tr><td>9</td><td>D board-Q334</td><td>52.7</td><td>71.4</td></tr> <tr><td>10</td><td>D board-Q384</td><td>59.1</td><td>77.9</td></tr> <tr><td>11</td><td>D board-Q432</td><td>59.7</td><td>78.5</td></tr> <tr><td>12</td><td>D board-U401</td><td>53.7</td><td>72.4</td></tr> <tr><td>13</td><td>F board-RG61</td><td>31.2</td><td>49.3</td></tr> <tr><td>14</td><td>F board-T602</td><td>36.5</td><td>54.7</td></tr> <tr><td>15</td><td>F board-U601</td><td>56.1</td><td>74.6</td></tr> <tr><td>16</td><td>F board-T601</td><td>39.1</td><td>57.1</td></tr> <tr><td>17</td><td>F board-Q671</td><td>34.9</td><td>52.5</td></tr> <tr><td>18</td><td>F board-Q621</td><td>59.1</td><td>75.6</td></tr> <tr><td>19</td><td>G board-D302</td><td>52.1</td><td>71.6</td></tr> <tr><td>20</td><td>G board-L301</td><td>65.2</td><td>85.0</td></tr> <tr><td>21</td><td>G board-C302</td><td>39.4</td><td>58.2</td></tr> <tr><td>22</td><td>H board-C714</td><td>26.7</td><td>48.6</td></tr> <tr><td>23</td><td>H board-R712</td><td>38.0</td><td>56.8</td></tr> <tr><td>24</td><td>H board-T702</td><td>56.0</td><td>75.6</td></tr> <tr><td>25</td><td>I board-RI11</td><td>34.8</td><td>52.5</td></tr> <tr><td>26</td><td>I board-D713</td><td>63.9</td><td>82.1</td></tr> <tr><td>27</td><td>TSW1</td><td>40.5</td><td>59.1</td></tr> <tr><td>28</td><td>RTH10</td><td>41.3</td><td>61.8</td></tr> <tr><td>29</td><td>RTH9</td><td>27.3</td><td>45.1</td></tr> <tr><td>30</td><td>D board-Q432(left)</td><td>52.7</td><td>71.9</td></tr> </tbody> </table>	NO	Position	ROOM AMBIENT Ta= 25 °C	HIGH AMBIENT Ta= 45 °C	1	A board-Q151	83.8	101.2	2	A board-D153	86.9	105.5	3	A board-Q100	76.9	94.5	4	A board-D108	81.3	99.7	5	A board-BD100	71.4	89.4	6	A board-BD151	83.7	101.8	7	A board-L151	38.2	57.1	8	D board-Q332	59.1	78.1	9	D board-Q334	52.7	71.4	10	D board-Q384	59.1	77.9	11	D board-Q432	59.7	78.5	12	D board-U401	53.7	72.4	13	F board-RG61	31.2	49.3	14	F board-T602	36.5	54.7	15	F board-U601	56.1	74.6	16	F board-T601	39.1	57.1	17	F board-Q671	34.9	52.5	18	F board-Q621	59.1	75.6	19	G board-D302	52.1	71.6	20	G board-L301	65.2	85.0	21	G board-C302	39.4	58.2	22	H board-C714	26.7	48.6	23	H board-R712	38.0	56.8	24	H board-T702	56.0	75.6	25	I board-RI11	34.8	52.5	26	I board-D713	63.9	82.1	27	TSW1	40.5	59.1	28	RTH10	41.3	61.8	29	RTH9	27.3	45.1	30	D board-Q432(left)	52.7	71.9
NO	Position	ROOM AMBIENT Ta= 25 °C	HIGH AMBIENT Ta= 45 °C																																																																																																																													
1	A board-Q151	83.8	101.2																																																																																																																													
2	A board-D153	86.9	105.5																																																																																																																													
3	A board-Q100	76.9	94.5																																																																																																																													
4	A board-D108	81.3	99.7																																																																																																																													
5	A board-BD100	71.4	89.4																																																																																																																													
6	A board-BD151	83.7	101.8																																																																																																																													
7	A board-L151	38.2	57.1																																																																																																																													
8	D board-Q332	59.1	78.1																																																																																																																													
9	D board-Q334	52.7	71.4																																																																																																																													
10	D board-Q384	59.1	77.9																																																																																																																													
11	D board-Q432	59.7	78.5																																																																																																																													
12	D board-U401	53.7	72.4																																																																																																																													
13	F board-RG61	31.2	49.3																																																																																																																													
14	F board-T602	36.5	54.7																																																																																																																													
15	F board-U601	56.1	74.6																																																																																																																													
16	F board-T601	39.1	57.1																																																																																																																													
17	F board-Q671	34.9	52.5																																																																																																																													
18	F board-Q621	59.1	75.6																																																																																																																													
19	G board-D302	52.1	71.6																																																																																																																													
20	G board-L301	65.2	85.0																																																																																																																													
21	G board-C302	39.4	58.2																																																																																																																													
22	H board-C714	26.7	48.6																																																																																																																													
23	H board-R712	38.0	56.8																																																																																																																													
24	H board-T702	56.0	75.6																																																																																																																													
25	I board-RI11	34.8	52.5																																																																																																																													
26	I board-D713	63.9	82.1																																																																																																																													
27	TSW1	40.5	59.1																																																																																																																													
28	RTH10	41.3	61.8																																																																																																																													
29	RTH9	27.3	45.1																																																																																																																													
30	D board-Q432(left)	52.7	71.9																																																																																																																													

		<table border="1"> <tr><td>31</td><td>D board-Q431(left)</td><td>55.0</td><td>73.9</td></tr> <tr><td>32</td><td>D board-Q384(left)</td><td>59.4</td><td>78.9</td></tr> <tr><td>33</td><td>D board-Q334(left)</td><td>53.5</td><td>72.7</td></tr> <tr><td>34</td><td>TSW1((left)</td><td>42.9</td><td>62.1</td></tr> <tr><td>35</td><td>RTH1(left)</td><td>46.5</td><td>65.4</td></tr> <tr><td>36</td><td>A board-Q201(left)</td><td>90.3</td><td>109.5</td></tr> <tr><td>37</td><td>A board-BD201(left)</td><td>59.9</td><td>78.4</td></tr> <tr><td>38</td><td>J board-D714(left)</td><td>25.8</td><td>31.1</td></tr> <tr><td>39</td><td>G board-C302(left)</td><td>39.5</td><td>59.6</td></tr> </table>			31	D board-Q431(left)	55.0	73.9	32	D board-Q384(left)	59.4	78.9	33	D board-Q334(left)	53.5	72.7	34	TSW1((left)	42.9	62.1	35	RTH1(left)	46.5	65.4	36	A board-Q201(left)	90.3	109.5	37	A board-BD201(left)	59.9	78.4	38	J board-D714(left)	25.8	31.1	39	G board-C302(left)	39.5	59.6
31	D board-Q431(left)	55.0	73.9																																					
32	D board-Q384(left)	59.4	78.9																																					
33	D board-Q334(left)	53.5	72.7																																					
34	TSW1((left)	42.9	62.1																																					
35	RTH1(left)	46.5	65.4																																					
36	A board-Q201(left)	90.3	109.5																																					
37	A board-BD201(left)	59.9	78.4																																					
38	J board-D714(left)	25.8	31.1																																					
39	G board-C302(left)	39.5	59.6																																					
2	OVER LOAD BURN-IN TEST	NO DAMAGE 1 HOUR (MIN)	I/P : 230 VAC(Δ) O/P : 101% LOAD Ta : 25°C	TEST : OK																																				
3	LOW TEMPERATURE TURN ON TEST	TURN ON AFTER 2 HOUR	I/P : 305VAC/230VAC(Δ) O/P : 100%/LOAD Ta= -30 °C	TEST : OK																																				
4	HIGH HUMIDITY HIGH TEMPERATURE HIGH VOLTAGE TURN ON TEST	AFTER 12 HOURS IN CHAMBER ON CONTROL 45 °C/95 %R.H NO DAMAGE	I/P : 230 VAC(Δ) O/P : FULL LOAD Ta= 45 °C HUMIDITY= 95 %R.H	TEST : OK																																				
5	TEMPERATURE COEFFICIENT	\pm 0.03 %/°C(0~45°C)	I/P : 230 VAC(Δ) O/P : FULL LOAD	\pm 0.01 %/°C(0~45°C)																																				
6	STORAGE TEMPERATURE TEST	-40~85°C	1. Thermal shock Temperature : -45°C~ +90°C 2. Temperature change rate : 25°C / MIN 3. Dwell time low and high temperature : 30 MIN/EACH 4. Total test cycle : 10 CYCLE 5. Input/Output condition : STATIC																																					
7	THERMAL SHOCK TEST	-30~45°C	1. Thermal shock Temperature : -35°C~ +50°C 2. Temperature change rate : 25°C / MIN 3. Dwell time low and high temperature : 30 MIN/EACH 4. Total test cycle : 16 CYCLE 5. Input/Output condition : 15cycle:230V/ FULL LOAD AC ON 3sec/AC OFF 1sec TEST 1cycle:230V/ FULL LOAD Burn In Test																																					
8	VIBRATION TEST	10 ~ 500Hz, 2G 10min./1cycle, 60min. each along X, Y, Z axes	1 Carton & 1 Set (1) Waveform : Sine Wave (2) Frequency : 10~500Hz (3) Sweep Time : 10min/sweep cycle (4) Acceleration : 3G (5) Test Time : 180min in each axis (X.Y.Z) (6) Ta : 25°C																																					
9	CAPACITOR LIFE CYCLE	SUPPOSE C714 IS THE MOST CRITICAL COMPONENT (1) I/P : 230VAC O/P : FULL LOAD Ta= 25 °C LIFE TIME (2) I/P : 230VAC O/P : FULL LOAD Ta= 45 °C LIFE TIME (3) I/P : 230VAC O/P : 75% LOAD Ta= 45 °C LIFE TIME (4) I/P : 230VAC O/P : 50% LOAD Ta= 45 °C LIFE TIME		(1) 3341270HRS (2) 732244HRS (3) 777945HRS (4) 872345HRS																																				
10	MTBF	Conducted by Parts Stress Analysis Prediction 121.9K hrs min. Telcordia SR-332 (Bellcore) ; 16.2K hrs min. MIL-HDBK-217F (25°C)																																						
11	Ongoing Reliability Test	I/P : 230VAC O/P : FULL LOAD TA=50°C Demonstration Mean Time Between Failure : 50,000 hours																																						



TEST RESULT	TESTER	REVIEW	APPROVAL
PASS	DANIEL GAO	SANFORD SU	VINCENT TSENG

2020.10.1 TAG-QA-009